



PICO®

8331 Specifications Sheet

Adhesive Lined Dual Wall 3:1 Shrink Tube

Flexible, thick adhesive lined dual wall shrink tubing manufactured by co extrusion of polyolefin and hot melt adhesive. Designed to provide both insulation and sealing.

Outline Drawings

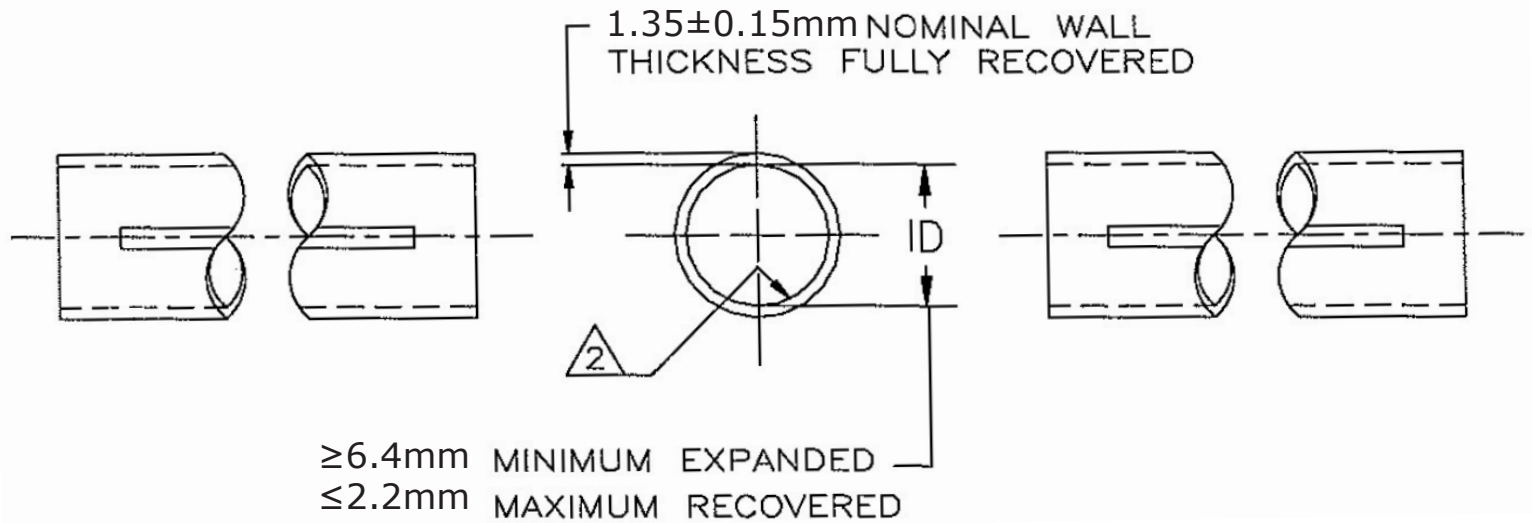

Notes

1. Material: Black polyolefin
2. Sealant throughout total length of inside diameter.
3. Dimensions apply without sealant.

Internal Diameter: ≥6.4mm
 Internal Diameter After Recovery: ≤2.2mm
 Wall Thickness After Recovery: 1.35±0.15mm
 Adhesive Thickness After Recovery: 0.70±0.1mm

Temperature Rated: -45°C - 125°C
 Shrink Temperature: 125°C - 200°C
 Rated for 600V applications.

*All colours but clear are UL approved components.



Technical Data

Property	Test Method	Standard
Tensile Strength (Mpa)	ASTM D2671	≥10.4
Elongation (%)	ASTM D2671	≥200
Tensile Strength After Aging (MPa)	UL 224 158°C x 168Hrs	≥7.3
Elongation At Break After Aging (%)	UL 224 158°C x 168Hrs	≥100
Dielectric Strength (kv/mm)	IEC 60243	≥15
Volume Resistivity (Ω .cm)	IEC 60093	≥1x10 ¹⁴
Water Absorption (%)	ASTM-D570	≤0.2%
Vicat Softening Point	ASTM-E28	95°C
Peel Strength (PE)	ASTM-D1000	120N/25mm
Peel Strength (AL)	ASTM-D1000	80N/25mm

Installation

PICO of Canada Ltd. offers a comprehensive selection of advanced shrink appliances that ensure process stability and repeatability.