



PICO®

8324 Specifications Sheet

Single Wall 2:1 Shrink Tube
Flame retardant multi-purpose heat shrink tubing.

Outline Drawings

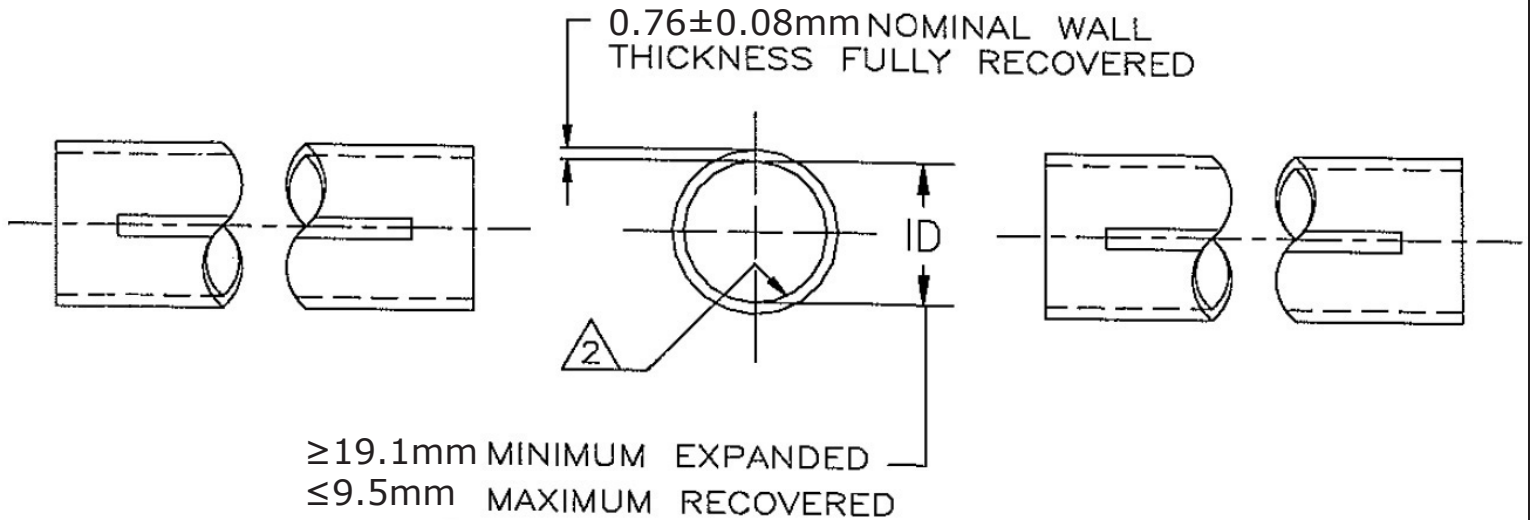

Notes

Meets or Exceeds SAE-AMS-DTL -23053/5 Class 1 and 3

Internal Diameter: $\geq 19.1 \text{mm}$
 Internal Diameter After Recovery: $\leq 9.5 \text{mm}$
 Wall Thickness After Recovery: $0.76 \pm 0.08 \text{mm}$

Temperature Rated: $-55^\circ\text{C} - 135^\circ\text{C}$
 Fully Shrink Temperature: 120°C
 Rated for 600V applications.
 All colours are UL approved except clear.



Technical Data

Property	Test Method	Performance
Tensile Strength (MPa)	ASTM D-2671	≥ 10.4
Ultimate Elongation (%)	ASTM D-2671	$\geq 200\%$
Tensile Strength After Heat Ageing (MPa)	175°C for 168hrs	≥ 7.3
Elongation after Heat Ageing (%)	175°C for 168hrs	$\geq 100\%$
Longitudinal change (%)	ASTM D-2671	$-5\% \pm 5\%$
Flammability	ASTM D-2671 C Method	VW-1
Voltage Withstand	UL 224, 2500V, 60s	No breakdown
Heat Shock	UL 224, 250°C x4 hrs	No cracks, flowing or dripping
Dielectric Strength (kV/mm)	ASTM D-149	≥ 15
Volume Resistivity (cm)	ASTM D-876	$\geq 10^{14}$
Fungus Resistance	SAE AS 23053-2016 Section 5.2 & ASTM G21-15	Grade 1

Installation

PICO of Canada Ltd. offers a comprehensive selection of advanced shrink appliances that ensure process stability and repeatability.