



# PICO®

## 8317 Specifications Sheet

Single Wall 2:1 Shrink Tube  
Flame retardant multi-purpose heat shrink tubing.

### Outline Drawings

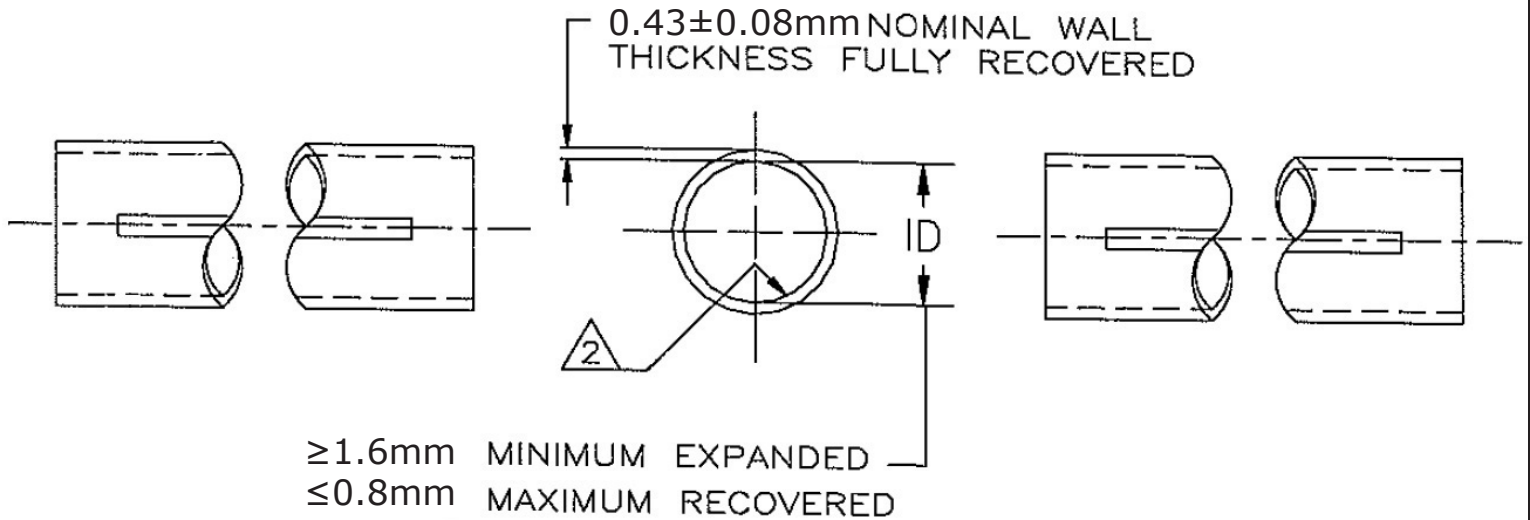

### Notes

Meets or Exceeds SAE-AMS-DTL -23053/5 Class 1 and 3

Internal Diameter: ≥1.6mm  
Internal Diameter After Recovery: ≤0.8mm  
Wall Thickness After Recovery: 0.43±0.08mm

Temperature Rated: -55°C - 135°C  
Fully Shrink Temperature: 120°C  
Rated for 600V applications.  
All colours are UL approved except clear.



### Technical Data

Property	Test Method	Performance
Tensile Strength (MPa)	ASTM D-2671	≥10.4
Ultimate Elongation (%)	ASTM D-2671	≥200%
Tensile Strength After Heat Ageing (MPa)	175°C for 168hrs	≥7.3
Elongation after Heat Ageing (%)	175°C for 168hrs	≥100%
Longitudinal change (%)	ASTM D-2671	-5% ± 5%
Flammability	ASTM D-2671 C Method	VW-1
Voltage Withstand	UL 224, 2500V, 60s	No breakdown
Heat Shock	UL 224, 250°C x4 hrs	No cracks, flowing or dripping
Dielectric Strength (kV/mm)	ASTM D-149	≥15
Volume Resistivity ( cm)	ASTM D-876	≥10 <sup>14</sup>
Fungus Resistance	SAE AS 23053-2016 Section 5.2 & ASTM G21-15	Grade 1

### Installation

PICO of Canada Ltd. offers a comprehensive selection of advanced shrink appliances that ensure process stability and repeatability.