

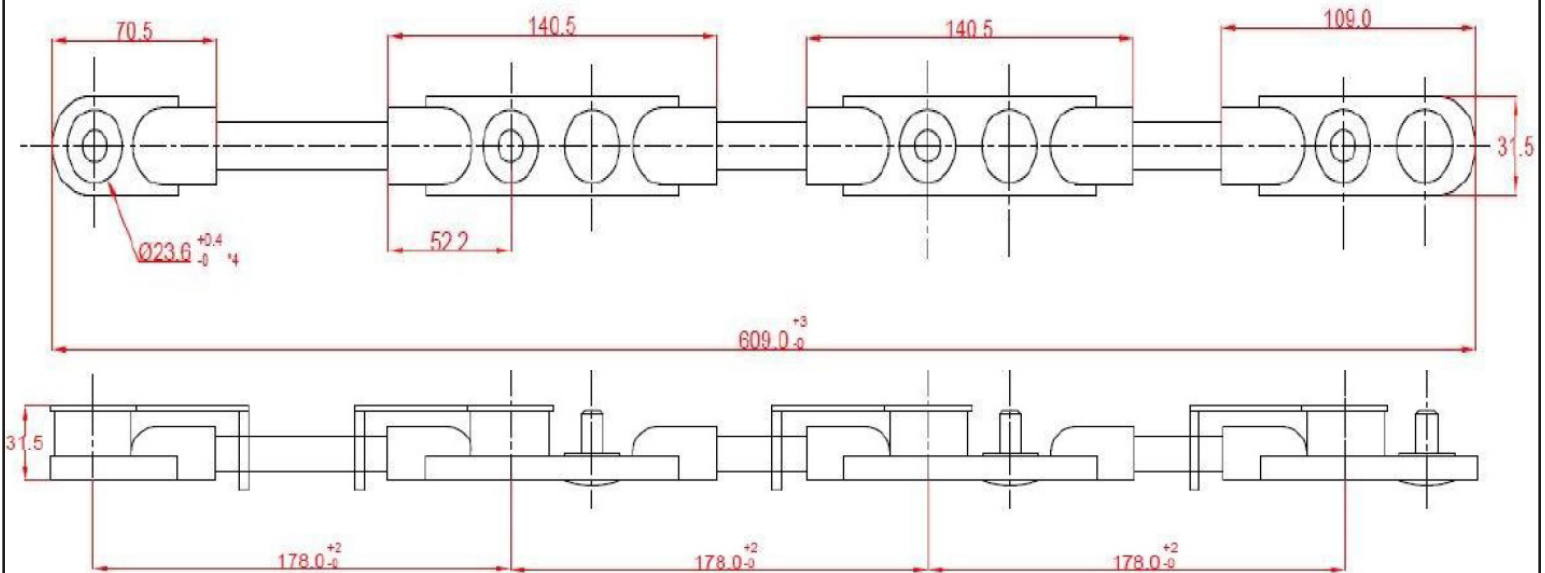

PICO®

6614, 6615 Specifications Sheet

Outline Drawings



Specifications

Input Voltage Rating	12 VDC - 48 VDC
Input Rating Current	220A (Normal Operations), 250A Max
Housing Material	PVC
Body Material	Cu + Ni Alloy (Bare Copper Twist) With PVC Insulation
Gauge	2/0 AWG
Polar Colour	Red = Positive Black = Negative
Operating Temperature	-20°C to 130°C
Dimensions (L x W x H)	609 x 31.5 x 31.5
Unit of Measurement	mm