

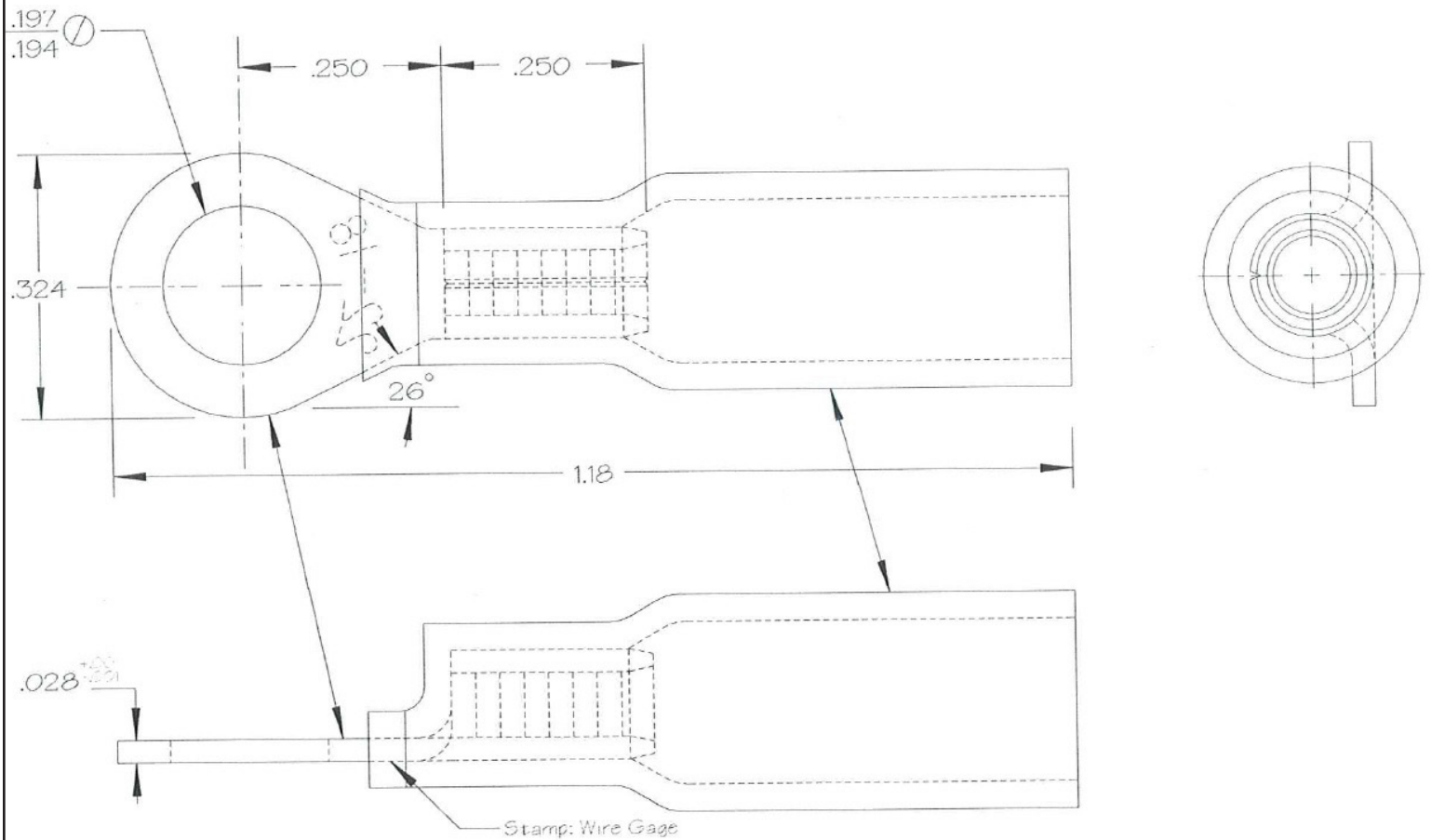

# PICO<sup>®</sup>

## 5805 Specifications Sheet

### Outline Drawings



### Terminal Notes

1. Material: ETP Alloy 110 Copper 1/2 Hard Temper ASTM Spec B152
2. Brazed Seam: 2% Silver 6.5% Phosphorus 91.5% Copper Approx. Melt Temp 715-850°C
3. Finish: Flash Electro Tin Plate ASTM Spec B545 Mil Spec: Mil-T-10727C Type I .0001-.00025 Thick
4. Heat Shrink Insulator Material: Semi-Rigid, Translucent, Adhesive Lined Tubing
5. Colour: Red